

F204 – 3U CompactPCI® M-Module Carrier Board

- **1 CompactPCI® bus slot**
- **1 M-Module slot**
- **-40 to +85°C versions with qualified components**



The F204 is a 3U M-Module carrier board for universal I/O on the CompactPCI® bus. It allows high flexibility in applications such as data acquisition or process control. One M-Module may be installed on the F204, which needs only one slot on the CompactPCI® bus. M-

Modules are screwed tightly on the board and require no separately mounted transition panel.

The F204 offers developers instant access to more than 70 different M-Modules for I/O in fields such as process I/O, measurement, instrumentation, motion control, communication, and development.

Diagram

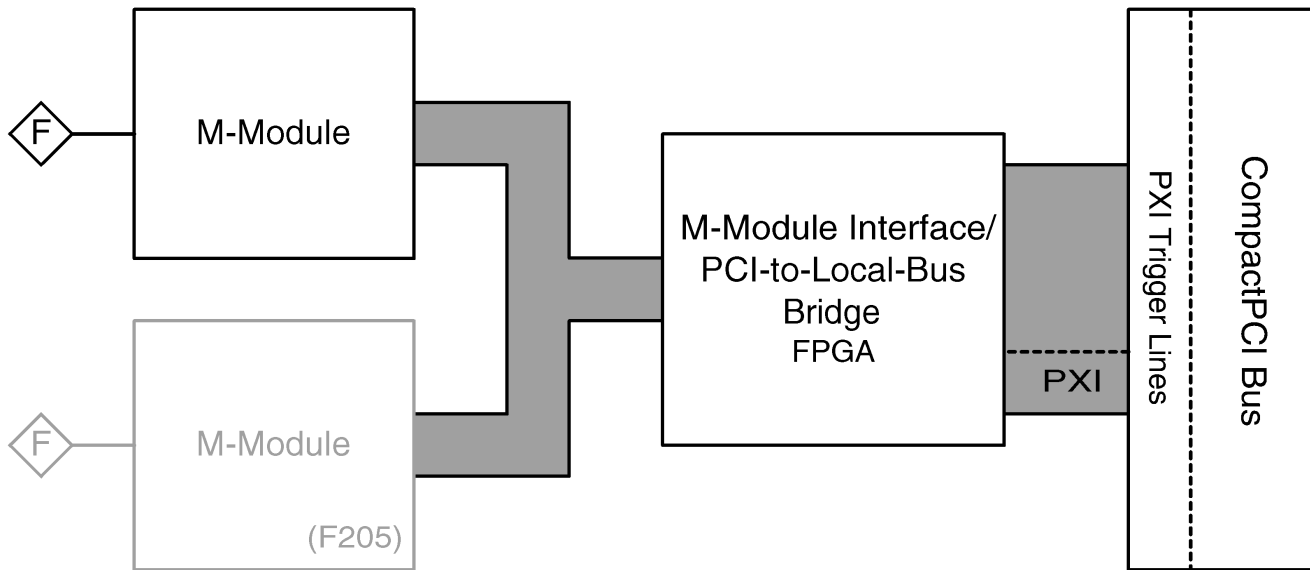

Technical Data

M-Module Slots	<ul style="list-style-type: none"> ■ One M-Module slot ■ Compliant with M-Module standard ■ Characteristics: A08, A24, D08, D16, D32, INTA, TRIGI, TRIGO
Peripheral Connections	<ul style="list-style-type: none"> ■ Via front panel
CompactPCI® Bus	<ul style="list-style-type: none"> ■ Compliance with CompactPCI® Specification 2.0 R2.1 ■ Only one slot required on the 3U CompactPCI® bus ■ 32-bit/33-MHz PCI-to-M-Module bridge <ul style="list-style-type: none"> □ FPGA-based □ Compliant with PCI Specification 2.2 □ Target on PCI bus ■ V(I/O): +3.3 V (+5 V tolerant)
Electrical Specifications	<ul style="list-style-type: none"> ■ Supply voltage/power consumption: <ul style="list-style-type: none"> □ +5 V (-3%/+5%), 20 mA typ. □ +3.3 V (-3%/+5%), 20 mA typ. ■ MTBF: 1 046 000h @ 40°C (derived from MIL-HDBK-217F)
Mechanical Specifications	<ul style="list-style-type: none"> ■ Dimensions: conforming to CompactPCI® specification for 3U boards ■ Front panel: aluminum with 1 handle, cut-out for front connector of M-Module ■ Weight: 130 g (without M-Modules)
Environmental Specifications	<ul style="list-style-type: none"> ■ Temperature range (operation): <ul style="list-style-type: none"> □ 0..+60°C or -40..+85°C □ Airflow: min. 10m³/h ■ Temperature range (storage): -40..+85°C ■ Relative humidity (operation): max. 95% non-condensing ■ Relative humidity (storage): max. 95% non-condensing ■ Altitude: -300 m to + 3 000 m ■ Shock: 15 g, 11 ms ■ Bump: 10 g, 16 ms ■ Vibration (sinusoidal): 2 g, 10..150 Hz ■ Conformal coating on request
Safety	<ul style="list-style-type: none"> ■ PCB manufactured with a flammability rating of 94V-0 by UL recognized manufacturers
EMC	<ul style="list-style-type: none"> ■ Tested according to EN 55022 (radio disturbance), IEC61000-4-2 (ESD) and IEC61000-4-4 (burst)
Software Support	<ul style="list-style-type: none"> ■ M-Module drivers for Windows®, VxWorks®, Linux, QNX®, OS-9® as supported ■ Basic board driver included in MDIS system package for the respective operating system

Configuration & Options

Standard Configurations

Article No.	M-Module Slots	M-Module Characteristics	Operation Temperature
02F204-00	1	A08/D16	0..+60°C
02F204-01	1	A08/D16	-40..+85°C
02F204-02	1	A24/D32	-40..+85°C
02F205-00	2	A08/D16	0..+60°C
02F205-01	2	A08/D16	-40..+85°C
02F205-05	2	A24/D32	-40..+85°C

Options

M-Module Slots	<ul style="list-style-type: none"> 1 or 2
M-Module Characteristics	<ul style="list-style-type: none"> A08/D16 or A24/D32
Operation Temperature	<ul style="list-style-type: none"> 0..+60°C -40..+85°C
Cooling Concept	<ul style="list-style-type: none"> Also available with conduction cooling in MEN CCA frame

Please note that some of these options may only be available for large volumes. Please ask our sales staff for more information.

Ordering Information

Standard F204 Models	02F204-00	M-Module carrier board for 1 M-Module, 0..+60°C
	02F204-01	M-Module carrier board for 1 M-Module, -40...+85°C screened
Miscellaneous Accessories	05M000-15	Front-panel cover for M-Module cut-outs at front panels, snap-in, 10 pcs
	05M000-17	25 mounting screw sets to fix M-Modules on carrier boards
Software: Miscellaneous	<p>Driver software for Windows®, Linux, VxWorks®, QNX®, RTX and OS-9® is available for the different M-Modules. Please refer to the M-Module/s of your choice for information and download.</p> <p>A basic board driver for this carrier card is included in the MDIS system package for the respective operating system. You can find an overview of available packages for download under www.men.de/mdis.</p>	

For operating systems not mentioned here [contact MEN sales](#).

Documentation	Compare Chart 3U CompactPCI® / PlusIO CPU cards » Download	
	Compare Chart 3U CompactPCI® / PlusIO peripheral cards » Download	
	20APPN001	Application Note: +5V cPCI Boards with +3.3V V(I/O)
	20F204-00	F204/F205 User Manual

Contact Information

Germany

MEN Mikro Elektronik GmbH
Neuwieder Straße 3-7
90411 Nuremberg
Phone +49-911-99 33 5-0
Fax +49-911-99 33 5-901

info@men.de
www.men.de

France

MEN Mikro Elektronik SAS
18, rue René Cassin
ZA de la Châtelaine
74240 Gaillard
Phone +33 (0) 450-955-312
Fax +33 (0) 450-955-211

info@men-france.fr
www.men-france.fr

USA

MEN Micro Inc.
860 Penllyn Blue Bell Pike
Blue Bell, PA 19422
Phone (215) 542-9575
Fax (215) 542-9577

sales@menmicro.com
www.menmicro.com

The date of issue stated in this data sheet refers to the Technical Data only. Changes in ordering information given herein do not affect the date of issue. All brand or product names are trademarks or registered trademarks of their respective holders.

MEN is not responsible for the results of any actions taken on the basis of information in the publication, nor for any error in or omission from the publication.

MEN expressly disclaims all and any liability and responsibility to any person, whether a reader of the publication or not, in respect of anything, and of the consequences of anything, done or omitted to be done by any such person in reliance, whether wholly or partially, on the whole or any part of the contents of the publication.

The correct function of MEN products in mission-critical and life-critical applications is limited to the environmental specification given for each product in the technical user manual. The correct function of MEN products under extended environmental conditions is limited to the individual requirement specification and subsequent validation documents for each product for the applicable use case and has to be agreed upon in writing by MEN and the customer. Should the customer purchase or use MEN products for any unintended or unauthorized application, the customer shall indemnify and hold MEN and its officers, employees, subsidiaries, affiliates, and distributors harmless against all claims, costs, damages, and expenses, and reasonable attorney fees arising out of, directly or indirectly, any claim or personal injury or death associated with such unintended or unauthorized use, even if such claim alleges that MEN was negligent regarding the design or manufacture of the part.

In no case is MEN liable for the correct function of the technical installation where MEN products are a part of.

Copyright © 2015 MEN Mikro Elektronik GmbH. All rights reserved.